

550











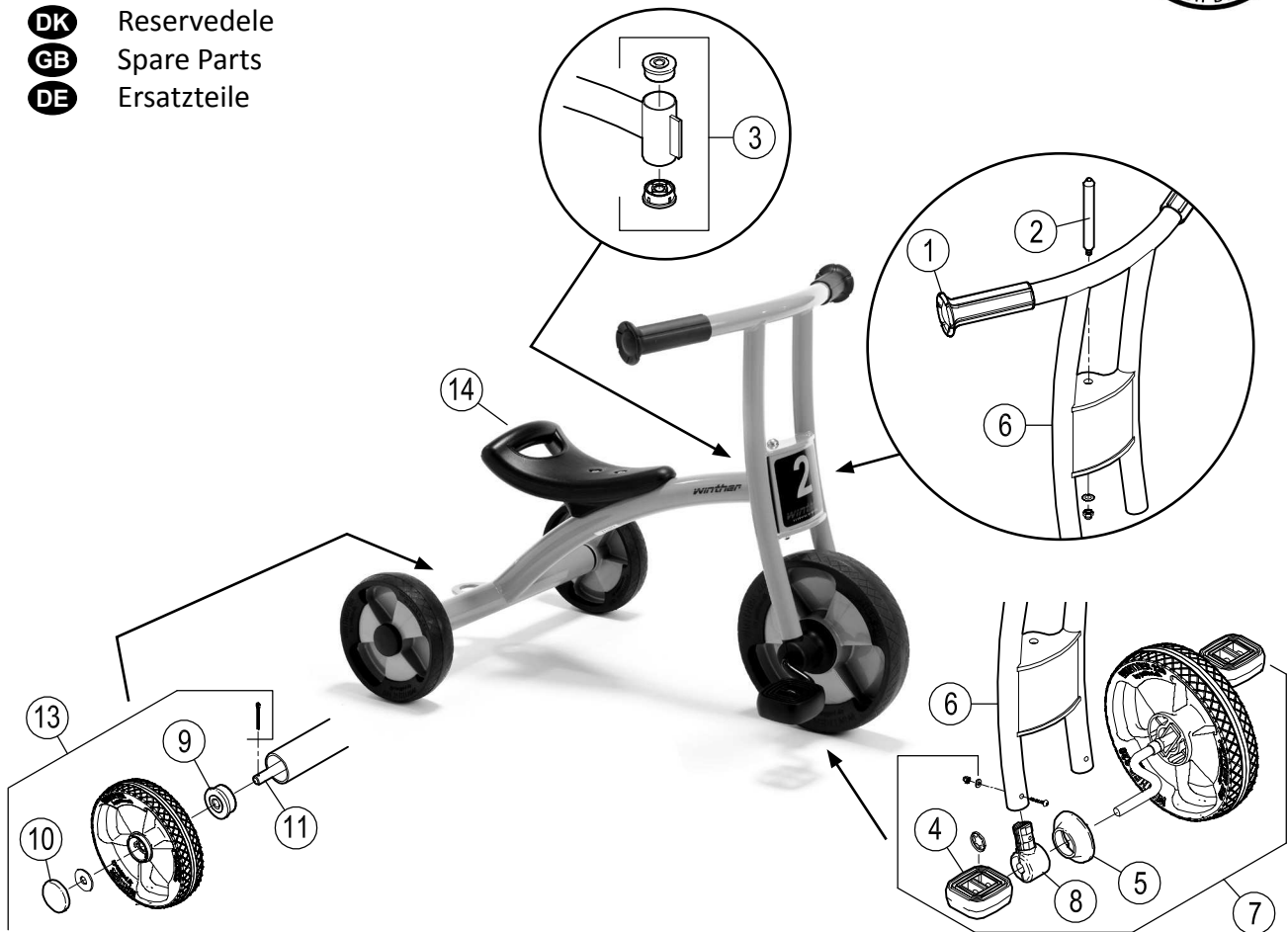













EN 71

ASTM F963

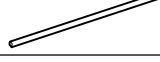

- DK** Reservedele
- GB** Spare Parts
- DE** Ersatzteile

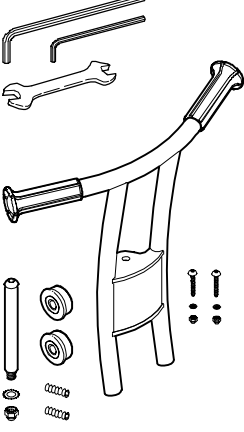
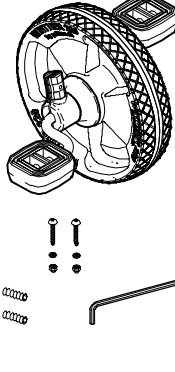

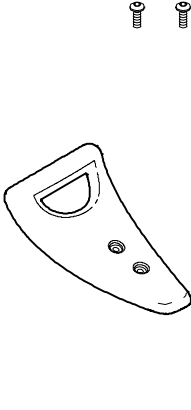
Pos.		Pos.	
1	 x2	8	 x2  x2  x2  x1
2	 x1  x2  x1  x1  x1	9	 x2
3	 x2	10	 x2
4	 x2  x2	11	 x1  x2  x2
5	 x2	12	
6		7	
13		14	



550



EN 71

ASTM F963



- DK** Reservedele
- GB** Spare Parts
- DE** Ersatzteile

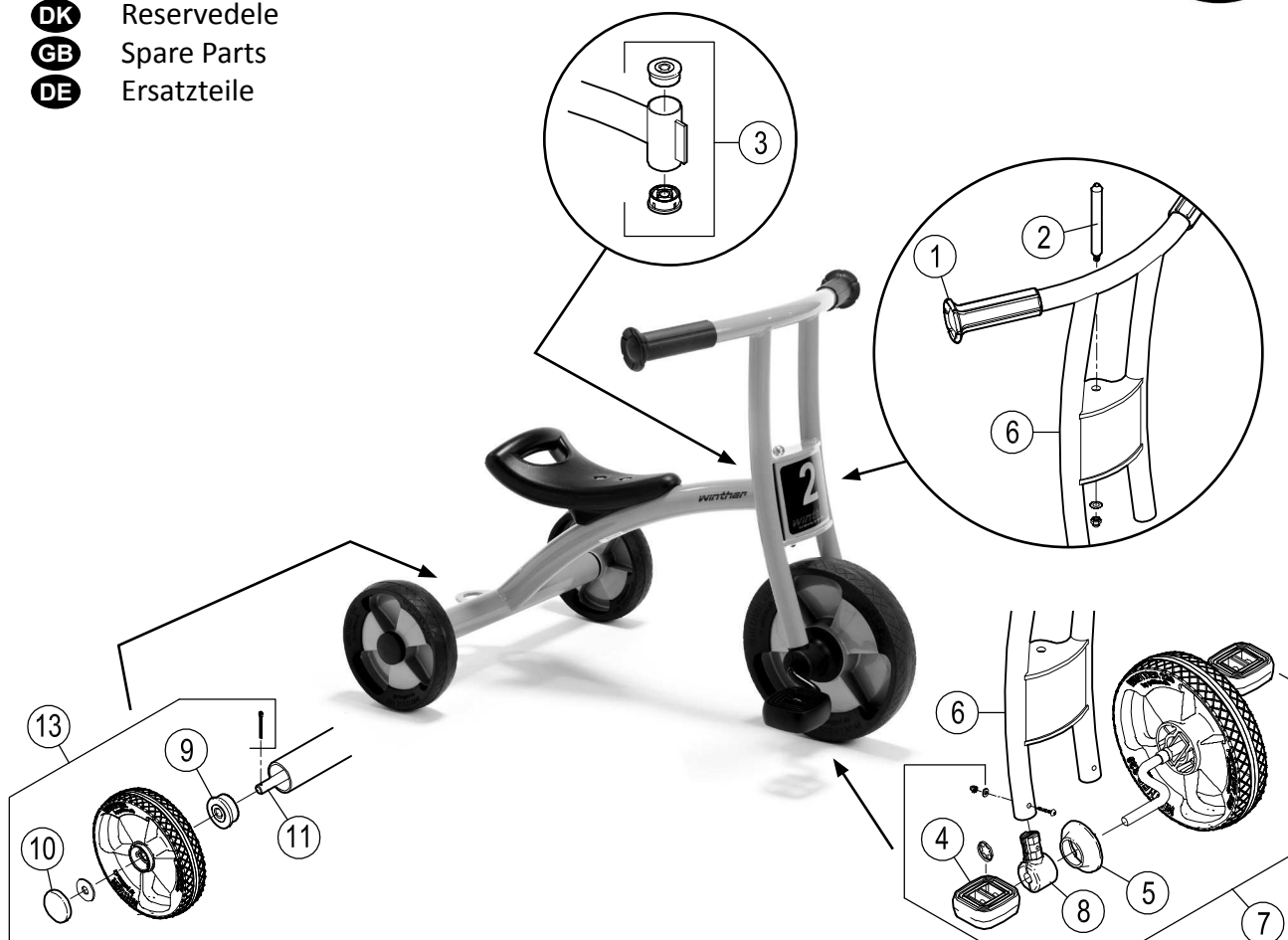

550.00					
Version					
Pos.	1.0	1.1			
1	50403	50403			
2	50401	50401			
3	50404	50404			
4	50410	50410			
5	50405	50405			
6	50450	50450			
7	50460	50460			
8	50406	50406			
9	50418	50418			
10	50421	50421			
11	50412	50412			
12	-	-			
13	50470	50470			
14	50480	50480			
15	-	-			
16	-	-			
17	-	-			
18	-	-			

